

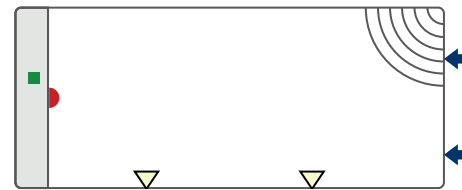



Specifications

COMMERCIAL SIZES	8,35 x 4,00 x 1,50m
COVER PIT	Integrated, 70 cm
WATER LEVEL	1,45 m
WEIGHT	1050 kg
WATER VOLUME	41 m³



 Standard lights (can be placed on opposite side)
 Drain  Injector  Suction connection

External (internal) dimensions / in cm – tolerance ± 2%

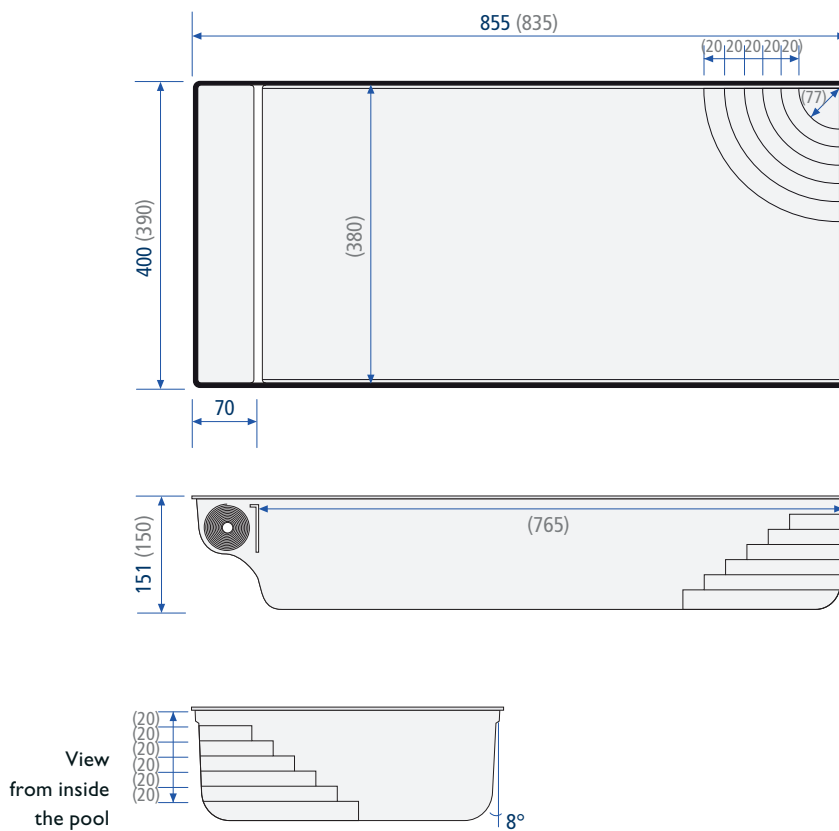

Digging sizes / in cm – tolerance ± 2%

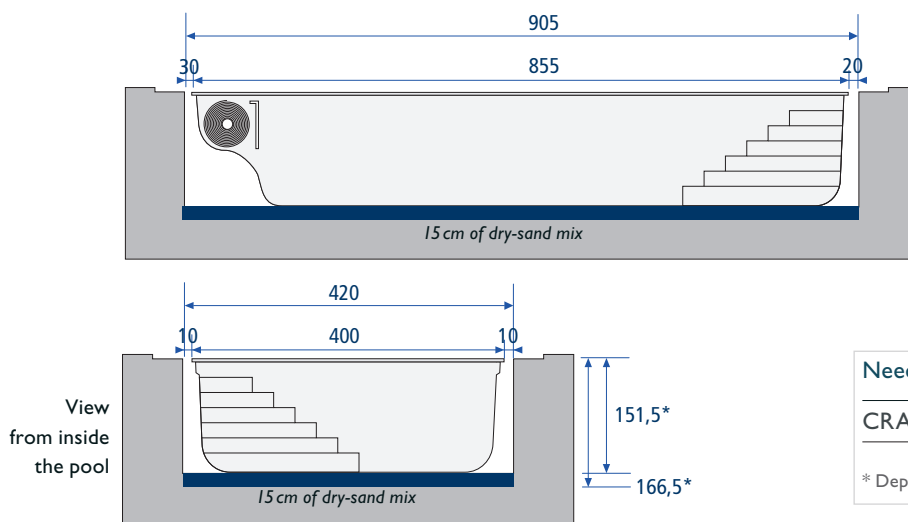

Needed for unloading & placing the pool

CRANE	13 tons
-------	----------------

* Depth taken from under the coping stone

Note : The digging sizes do not take into account the necessary space for the coping stones.